

P 531 501  
P 531 801  
P 531 121

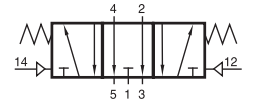

P 532 501  
P 532 801  
P 532 121

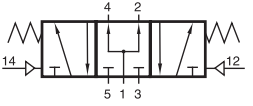

P 533 501  
P 533 801  
P 533 121

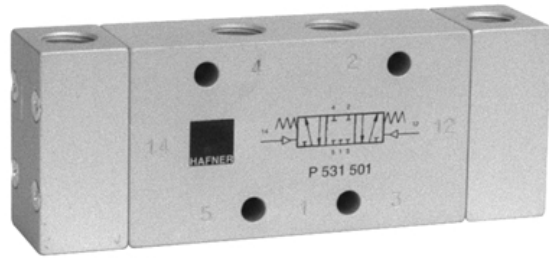

Pneumatically actuated 5/3-way spool valve with spring return to middle position.

Type 531 Middle position closed

Type 532 Middle position exhausted

Type 533 Middle position pressurized

When ordering, please complete the type number by 1, 2 or 3, according to the type in need.

Exhaust can be throttled at 3 and 5.

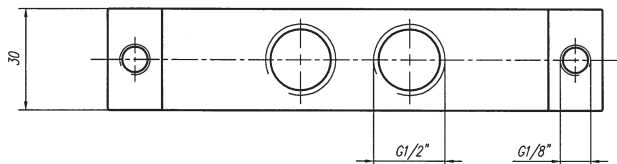
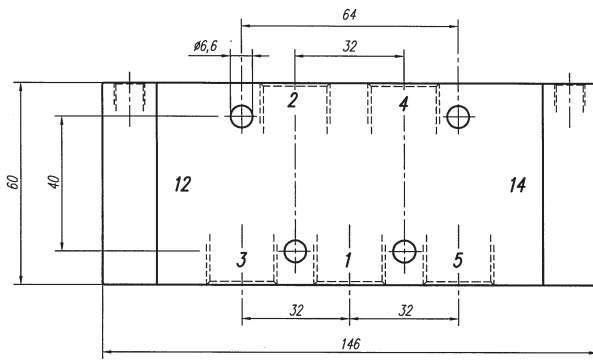
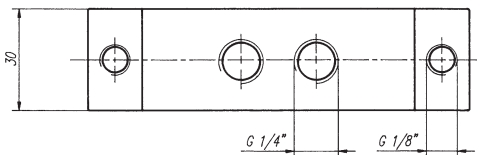
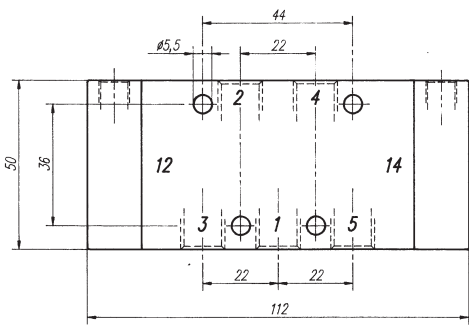
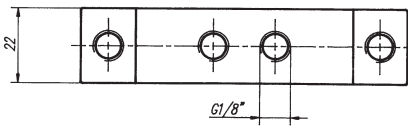
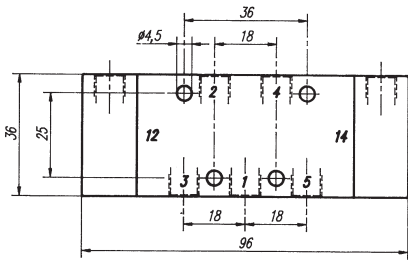

Type	Port size	Air flow	Operating press.	Actuation press.	Weight
P 53_ 501	G 1/8"	650 l/min	1 - 10 bar	3 - 10 bar	0,19 kg
P 53_ 801	G 1/4"	1450 l/min	1 - 10 bar	3 - 10 bar	0,46 kg
P 53_ 121	G 1/2"	3000 l/min	1 - 10 bar	3 - 10 bar	0,67 kg

2.4.3.1.